



filmo ki bhook badaye

Shree Krishna
Food Equipment & Supplies Pvt. Ltd.

- History -

The Early 1990s

That's where our story starts, in a humble 200 square foot office.

Fast Forward to 1997

Imported US Corn for Popcorn was first introduced by us to cinemas across India.

Years later...

Popcorn got a CRUNCHY upgrade! We introduced international, rich flavours, seasoning and top-notch popcorn poppers and warmers from C. Creators.

Present

We popcorn-ed our way from kernels to a diverse kingdom, offering world class popcorn packaging like paper buckets & paper tubs, trays, flavours and everything in between!

- Mission -

To provide high-quality, innovative food equipment and supplies, giving our end-users the best experience while prioritising eco-sensibility and contributing to a greener future.

- Vision -

To be a responsible industry leader in sustainable packaging, food equipment, and products, contributing positively to health, entertainment, and the environment through innovation and eco-friendly practices.

- Company Info -

We're committed to freeing nature from plastic waste, with millions of tons generated annually and over 90% unrecycled.

Recyclable



Eco - Friendly



100% Compostable and Recyclable



Entirely Plastic-Free



Cost-Effective and Efficient Machines



Premium quality imported popcorns



- Verticals -



100%
Compostable
Paper
Packaging



Popcorn
Poppers
And
Warmers



Instant
Pop-corn
Pre-mixes &
Flavours

- Allied Services and Accessories -

Caddy Trays

Service Trays

Popcorn KIOSK
Franchise

Popcorn KIOSK
Setup

Cinema Concession
Setup

Packaging

100%
Compostable
100%
Plastic-Free

PAPER PACKAGING



Scan for more



As pioneers of 100% compostable paper packaging in India, we design eco-friendly products using sustainable materials to minimise environmental impact, available at QSRs and malls.



Paper Tubs and Buckets

Available in - 32oz, 46oz, 50oz, 65oz, 75oz, 85oz, 130oz, 170oz

Food Container

Available in - 300ml, 400ml, 500ml, 1000ml, 1250 ml



Food Boxes

Available in sizes - 300ml, 400ml, 500ml, 750ml, 1000ml, 1500ml, 2000ml



Paper Boat Trays

Available in various sizes



Noodle Box

Available in various sizes



Food

Instant Popcorn PRE-MIXES And FLAVOURS



350 gms

150 gms

70 gms

40 gms

40 gms

70 gms

150 gms

Scan for more

Discover our Instant Popcorn Pre-Mixes and Flavours in India, offering healthy, crunchy popcorn available in both institutional and retail packs.



Instant Popcorn PRE-MIXES



350 gms

Retail packs available in 40gm, 70gms, 150gms

FLAVOURS



Available in flavours: Classic Butter, Cheese, Salt,
Peri Peri, Tomato, Chat, Caramel

Machines

Popcorn POPPERS And WARMERS



Scan for more



Our range of premium popcorn poppers, warmers, and trolleys, available in different sizes, are designed for unwavering stability and consistent performance. Ensuring a smooth and satisfying customer experience is a priority, and we intend to uphold that!

Warmer

TECHNICAL SPECIFICATION

Sr.	Technical Parameters	Specifications
1	Model	CinePOP CURVE / FLAT - 24" / 30" / 36"
Product Specification 24"		
1	Dimensions (WxDxH) in MM	610 x 720 x 690
2	Net Weight	48 Kg
Product Specification 30"		
1	Dimensions (WxDxH) in MM	762 x 720 x 690
2	Net Weight	54 Kg
Product Specification 36"		
1	Dimensions (WxDxH) in MM	914 x 720 x 690
2	Net Weight	60 Kg
Electrical Specification		
1	Dimensions (WxDxH) in MM	30" / 36" - 3900 watts (Max.) 24" - 2800 watts (Max.)
2	Power Supply	230V AC/50 Hz
Accessories		
1	Stainless Steel Scoop	2 PC

*Technical Specifications are subject to change without prior notice.

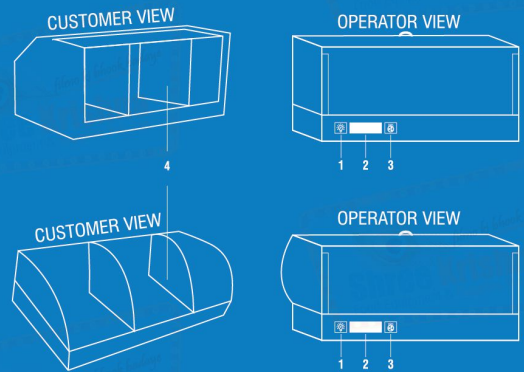

1. LIGHT 2. THERMOSTAT 3. WARMER 4. DIVIDER



Corn Popping Machine

TECHNICAL SPECIFICATION

Sr.	Technical Parameters	Specifications
1	Model	CinePOP I/II/III WorkHorse/NextGen
Product Specification		
1	Dimensions (WxDxH) in MM	32 Oz / 16oz - 780 x 750 x 1070 8 Oz - 580 x 580 x 875
2	Net Weight	32 Oz - 98 Kg / 16 Oz - 92 Kg / 8 Oz - 43 Kg
Electrical Specification		
1	Power Rating	32 Oz - 3900 watts (Max.) 16 Oz - 2800 watts (Max.) 8 Oz - 1325 watts
2	Power Supply	230V AC / 50 Hz
Recommended Input Parameters		
1	Dried Corn Kernels	Mfr. Recommended
2	Salt / Caramel Powder	Mfr. Recommended
3	Edible Oil	Mfr. Recommended
Accessories		
1	Stainless Steel Scoop	1 PC
2	Kettle Cleaner	1 PC

*Technical Specifications are subject to change without prior notice.

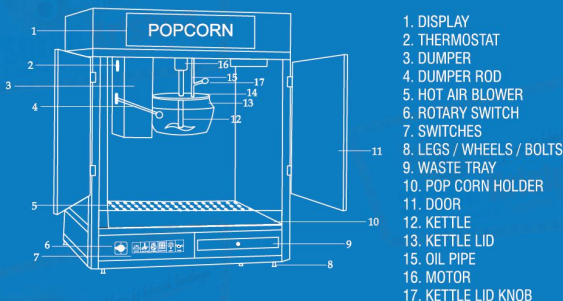

1. DISPLAY
2. THERMOSTAT
3. DUMPER
4. DUMPER ROD
5. HOT AIR BLOWER
6. ROTARY SWITCH
7. SWITCHES
8. LEGS / WHEELS / BOLTS
9. WASTE TRAY
10. POP CORN HOLDER
11. DOOR
12. KETTLE
13. KETTLE LID
15. OIL PIPE
16. MOTOR
17. KETTLE LID KNOB

Tubs Sizes

225.94mm / 8.895in

170 Oz Family Tub



200mm / 7.874in

161.38mm / 6.353in

Tubs	200 P/Box	Box	2 Kg	20ft HC
Paper Board	340 GSM	Box	10.8Kg	160 Box
Tub Weight	42 Gms	MOQ Brand	20000	
Salted Popcorn	200 Gms	Box (L)H Dimensions	40ft HC	
Caramel	300 Gms	Box (L)H Dimensions	332 Box	
Chicken	15 Pieces	711X 469 X 546mm 28 X 18.5 X 21.5in		

Copyright © design: 147029

192.1mm / 7.562in

130 Oz MegaTub (Tall)



210mm / 8.267in

120mm / 4.724in

Tubs	150 P/Box	Box	2.4 Kg	20ft HC
Paper Board	300 GSM	Box	14.2Kg	
Tub Weight	34 Gms	MOQ Brand	10000	
Salted Popcorn	130 Gms	Box (L)H Dimensions	40ft HC	
Caramel	200 Gms	889 X 457 X 610mm 35 X 18 X 24inch		
Chicken	12 Pieces			

Copyright © design: 147029

215.54mm / 8.485in

130 Oz MegaTub (Short)



166mm / 6.535in

161mm / 6.338in

Tubs	230 P/Box	Box	2 Kg	20ft HC
Paper Board	300 GSM	Box	8.8Kg	160 Box
Tub Weight	34 Gms	MOQ Brand	10000	
Salted Popcorn	140 Gms	Box (L)H Dimensions	40ft HC	
Caramel	210 Gms	711X 469 X 546mm 28 X 18.5 X 21.5in	332 Box	
Chicken	12 Pieces			

Copyright © design: 147029

177mm / 6.968in

85 Oz LargeTub



160mm / 6.299in

120mm / 4.724in

Tubs	500 P/Box	Box	2.8 Kg	20ft HC
Paper Board	270 GSM	Box	15.6Kg	
Tub Weight	26 Gms	MOQ Brand	20000	
Salted Popcorn	90 Gms	Box (L)H Dimensions	40ft HC	
Caramel	150 Gms	889 X 546 X 546mm 35 X 21.5 X 21.5in		
Chicken	6 Pieces			

Copyright © design: 147029

174.22mm / 6.859in

75 Oz LargeTub



155mm / 6.102in

131.03mm / 5.128in

Tubs	450 P/Box	Box	2.8 Kg	20ft HC
Paper Board	270 GSM	Box	15.2Kg	
Tub Weight	28 Gms	MOQ Brand	20000	
Salted Popcorn	95 Gms	Box (L)H Dimensions	40ft HC	
Caramel	150 Gms	889 X 546 X 546mm 35 X 21.5 X 21.5in		
Chicken	8 Pieces			

Copyright © design: 147029

170mm / 6.692in

65 Oz Small Tub



140mm / 5.511in

131.03mm / 5.158in

Tubs	500 P/Box	Box	2.6 Kg	20ft HC
Paper Board	270 GSM	Box	15.4Kg	
Tub Weight	25 Gms	MOQ Brand	20000	
Salted Popcorn	80 Gms	Box (L)H Dimensions	40ft HC	
Caramel	150 Gms	889 X 546 X 571.5mm 35 X 21.5 X 22.5in		
Chicken	6 Pieces			

Copyright © design: 147029

162mm / 6.377in

50 Oz Small Sr. Tub



210mm / 8.33in

120mm / 4.724in

Tubs	575 P/Box	Box	2.8 Kg	20ft HC
Paper Board	238 GSM	Box	13.2Kg	
Tub Weight	18 Gms	MOQ Brand	20000	
Salted Popcorn	55 Gms	Box (L)H Dimensions	40ft HC	
Caramel	100 Gms	889 X 546 X 546mm 35 X 21.5 X 21.5in		
Chicken	5 Pieces			

Copyright © design: 147029

121.8mm / 4.795in

46 Oz Small Jr. Tub



165mm / 6.496in

90.1mm / 3.547in

Tubs	1000 P/Box	Box	2 Kg	20ft HC
Paper Board	238 GSM	Box	18.2Kg	144 Box
Tub Weight	16 Gms	MOQ Brand	20000	
Salted Popcorn	50 Gms	Box (L)H Dimensions	40ft HC	
Caramel	90 Gms	822 X 495 X 506mm 24.5 X 19.5 X 20in	380 Box	
Noodle/Nugget				

Copyright © design: 147029

117mm / 6.968in

32 Oz Mini Tub



138mm / 5.433in

90.1mm / 3.547in

Tubs	1000 P/Box	Box	1.8 Kg	20ft HC
Paper Board	238 GSM	Box	15.6 Kg	225 Box
Tub Weight	13 Gms	MOQ Brand	20000	
Salted Popcorn	40 Gms	Box (L)H Dimensions	40ft HC	
Caramel	80 Gms	610 X 483 X 457mm 24 X 19 X 18in	455 Box	
Noodle/Nugget				

Copyright © design: 147029

Food Container

124mm / 4.921in

1250ml 1.25 Litres

500 Pcs/Box 300 GSM

135mm / 5.394in

100mm / 3.937in

Plastic Free – 100% Compostable
ITC Filo Series Paper or Similar

Heat Seal Paper Lid

Printed Single Layer Lid & Heat Seal Lid Available

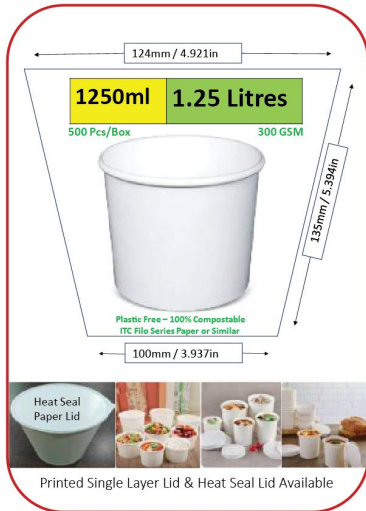

124mm / 4.921in

1000ml 1 Litre

500 Pcs/Box 300 GSM

115mm / 4.527in

100mm / 3.937in

Plastic Free – 100% Compostable
ITC Filo Series Paper or Similar

Heat Seal Paper Lid

Printed Single Layer Lid & Heat Seal Lid Available

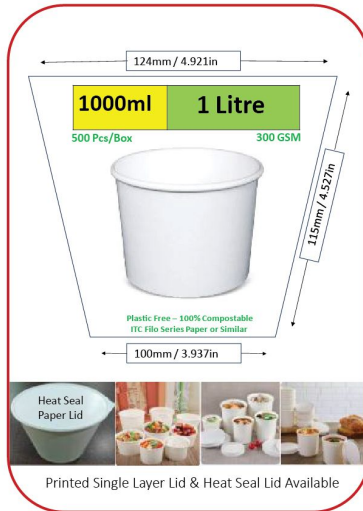

124mm / 4.921in

750ml 0.75 Litre

500 Pcs/Box 300 GSM

95mm / 3.74in

100mm / 3.937in

Plastic Free – 100% Compostable
ITC Filo Series Paper or Similar

Heat Seal Paper Lid

Printed Single Layer Lid & Heat Seal Lid Available

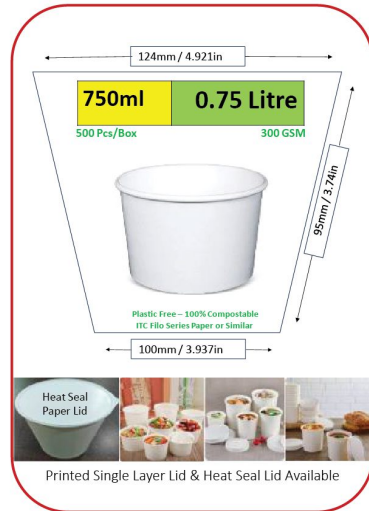

105mm / 4.133in

600ml 0.6 Litre

500 Pcs/Box 250 GSM

90mm / 3.543in

88mm / 3.464in

Plastic Free – 100% Compostable
ITC Filo Series Paper or Similar

Heat Seal Paper Lid

Printed Single Layer Lid & Heat Seal Lid Available

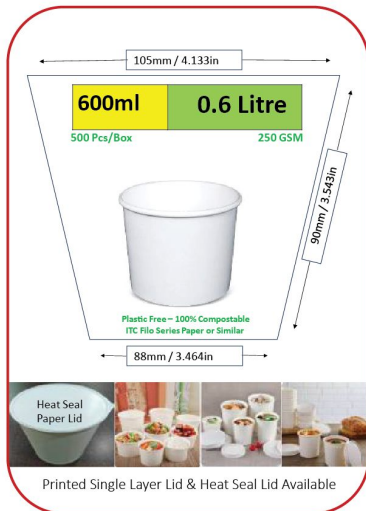

105mm / 4.133in

500ml 0.5 Litre

500 Pcs/Box 250 GSM

80mm / 3.149in

88mm / 3.464in

Plastic Free – 100% Compostable
ITC Filo Series Paper or Similar

Heat Seal Paper Lid

Printed Single Layer Lid & Heat Seal Lid Available

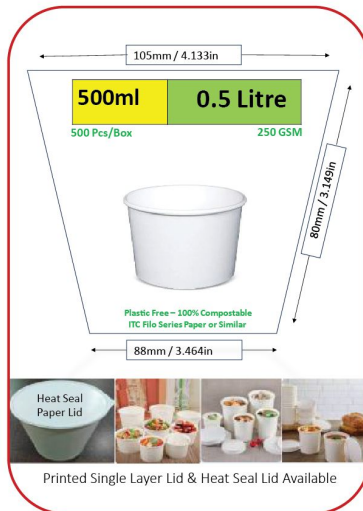

105mm / 4.133in

400ml 0.4 Litre

500 Pcs/Box 250 GSM

60mm / 2.362in

88mm / 3.464in

Plastic Free – 100% Compostable
ITC Filo Series Paper or Similar

Heat Seal Paper Lid

Printed Single Layer Lid & Heat Seal Lid Available

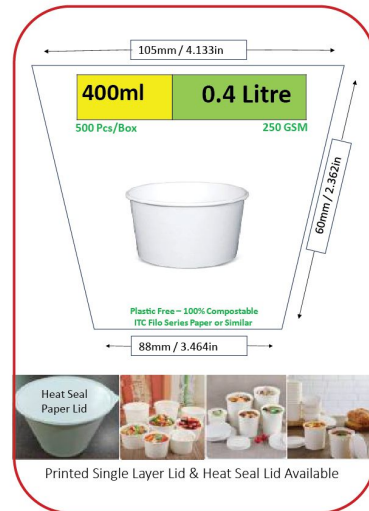

105mm / 4.133in

300ml 0.3 Litre

500 Pcs/Box 250 GSM

52mm / 2.047in

88mm / 3.464in

Plastic Free – 100% Compostable
ITC Filo Series Paper or Similar

Heat Seal Paper Lid

Printed Single Layer Lid & Heat Seal Lid Available

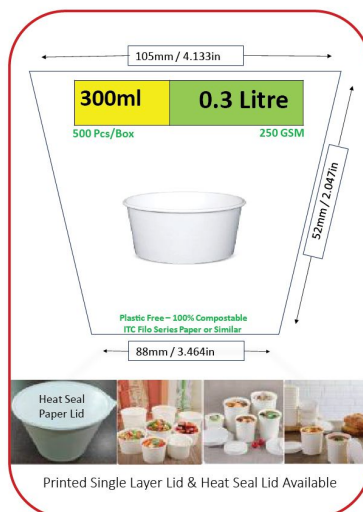

Paper v/s Plastic Comparision Chart

Compostable Paper Packaging Solution



RECYCLABLE



Microwave Safe



- ✓ Good for Food
- ✓ Caring for your Customers
- ✓ Pocket Friendly
- ✓ Enviroment Friendly
- ✓ Food Grade & Legal
- ✓ Change and Gain



Cancer Causing Plastic Packaging Option



- ✗ Bad for Health
- ✗ Poisoning your Customers
- ✗ Cheaper Now, Expensive Later
- ✗ Bad for Enviroment
- ✗ Gravely Illegal
- ✗ Continue to Hell

Choose health, Choose environment, Say NO to Plastic

Say YES to Health, Environment & NO to Plastic





Contact Us



Email

skfespl@gmail.com



Contact Number

+91 99206 69956

+91 98673 55556



Our Address



Follow Us